

# MT621

## ■ Dimensions(mm)

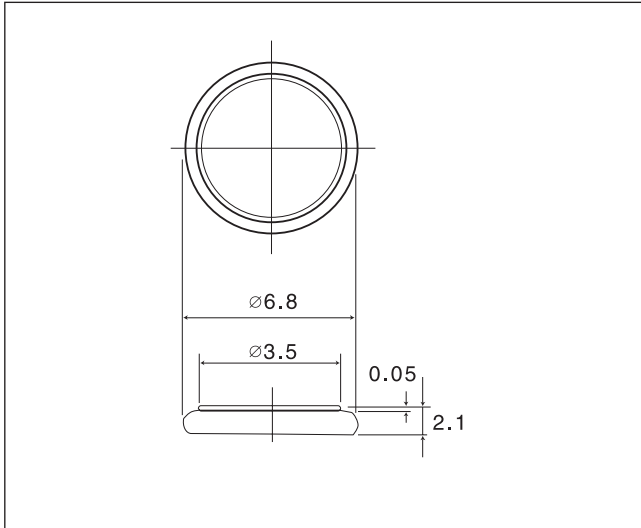

## ■ Specification

Nominal voltage(V)	1.5
Nominal capacity(mAh)	2.5
Continuous drain(mA)	0.05
Operating temperature(°C)	-10 to +60

## ■ Discharge characteristics

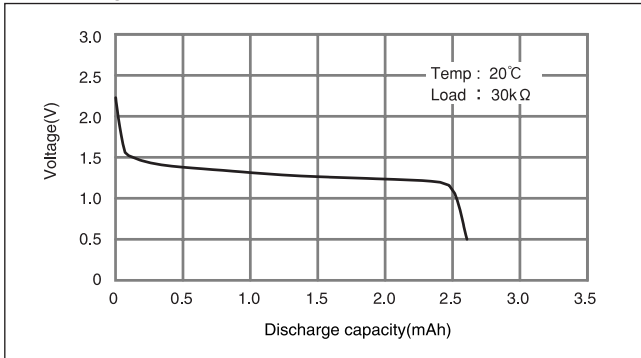

## ■ Consumption current vs. duration time

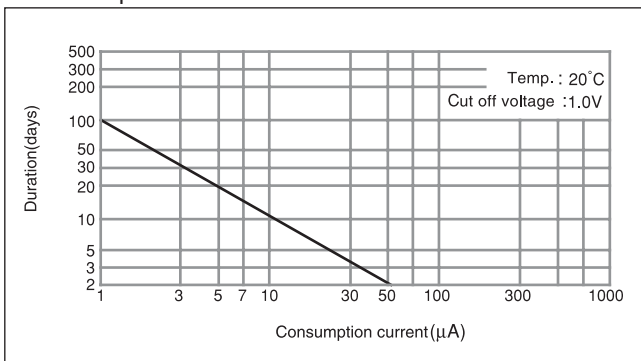

# MT920

## ■ Dimensions(mm)

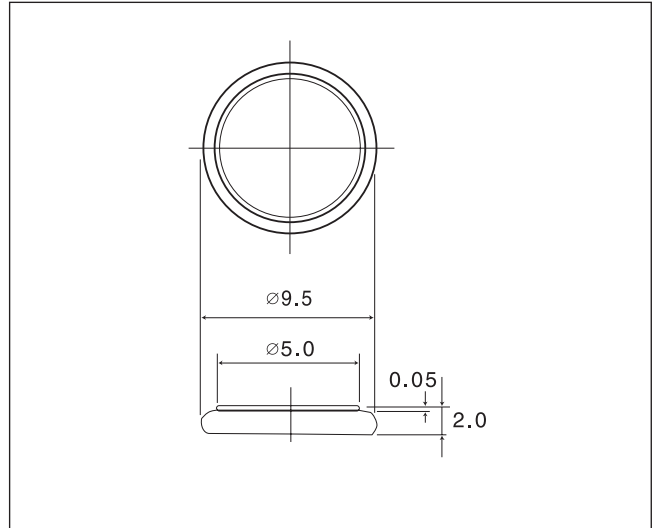

## ■ Specification

Nominal voltage(V)	1.5
Nominal capacity(mAh)	5.0
Continuous drain(mA)	0.05
Operating temperature(°C)	-10 to +60

## ■ Discharge characteristics

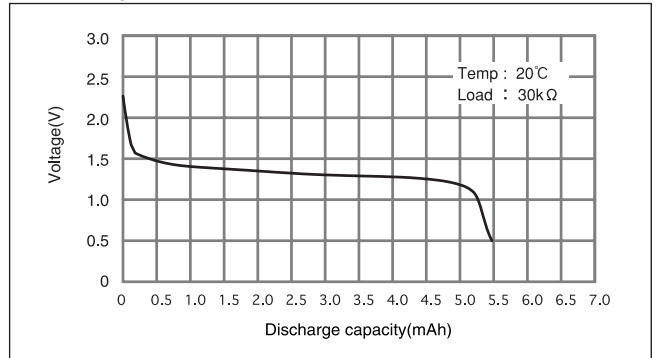

## ■ Consumption current vs. duration time

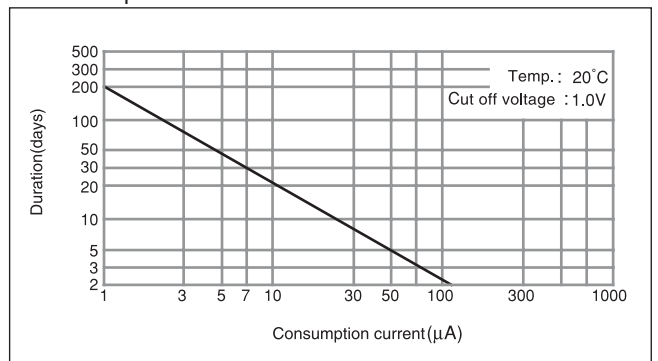

## ■ Discharge temperature characteristics

